







22 585 671



- sporgenza 195 mm
- bocca fissa
- Getto squadrato con aria
- altezza totale 1038 - 1103 mm
- altezza fino a rompigitto 970 – 1040 mm
- rosetta Ø 135 mm
- portata max 4,6 l/min
- senza piombo
- Questo prodotto può aiutare un edificio a soddisfare i requisiti dei Green Building Rating Systems, ad es. LEED®, BREEAM®, DGNB

	Cromato	22 585 671-00
	Platinato spazzolato	22 585 671-06
	Dark Chrome	22 585 671-19
	Light Gold spazzolato	22 585 671-27
	Nero opaco	22 585 671-33
	Cromo spazzolato	22 585 671-93
	Dark Platinum spazzolato	22 585 671-99

Prodotti complementari necessari



Fissaggio a pavimento da incasso 35 945 970 90

- profondità d'incasso min. 80 mm
- Profondità d'incasso max. 150 mm

Prodotti complementari necessari



Fissaggio a pavimento da incasso 35 945 970 90

- profondità d'incasso min. 80 mm
- Profondità d'incasso max. 150 mm

22 585 671

mm [inches]

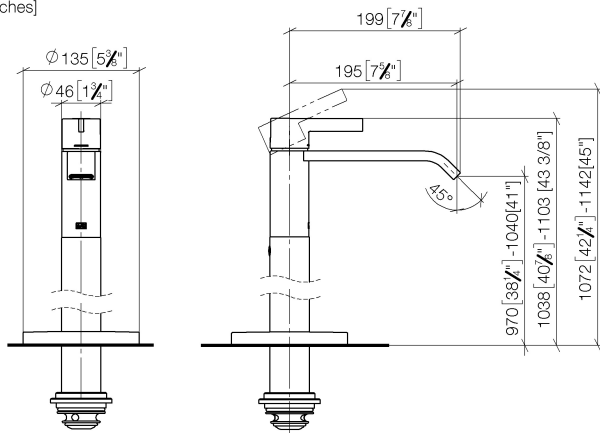

Diagramma di portata

